



## PRODUCT OVERVIEW

INNOVATIVE VALVE TECHNOLOGY

Engineering . Valves . Solutions .

G

S

R<sup>®</sup>



## INNOVATIVE VALVE TECHNOLOGY — MADE IN GERMANY

With a product range of several thousand valve types, we offer you valve solutions for virtually any application.

Our range of standard valves includes over 1,000 valve combinations with four different types of control. In addition, we have a wide range of customised valves that have been developed in close coordination with the user for specific purposes. We have comprehensive engineering expertise and a proven modular system of components and options at our disposal. We supply customers in mechanical and plant engineering, washing technology, shipbuilding and many other areas where reliable components are needed. Especially for use in high-pressure applications with pressure ranges up to 1,000 bar and high-temperature applications up to 400 °C, we can draw on state-of-the-art valve technology. As innovative valve manufacturers, we have developed a 1,000 bar valve for hydrogen infrastructure, for example, and a completely new valve concept with switching times in the ms range. Through these and many other activities, we have already made adapted to areas that will become increasingly important in future, such as CNG and hydrogen, making us a professional partner on whom you can continue to rely.

Our core competence lies in rapid development of customised solutions in all areas of valve technology. We cover a very broad spectrum. This includes valve size (from DN1 to DN300), pressure range (from the vacuum range to 1,000 bar) and temperature range (from -196 °C to +400 °C).

We have 50 years of experience, work with very high vertical integration and use state-of-the-art production and testing technology. Since all the essential components are produced on state-of-the-art machines in-house, both customised products and larger series can be delivered at short notice with the highest quality.

All business processes are compliant with DIN EN ISO 9001 and are continuously monitored and improved by our quality management and technical development systems.

The GSR logo is a registered trademark of GSR Ventiltechnik GmbH & Co. KG

Note: All texts and images are the property of GSR Ventiltechnik GmbH & Co. KG and may not be reproduced or changed without written permission, even as extracts.

Original products may vary from the product photos shown because of different materials, etc.

Errors and changes, version 02/2022

A company of INDUS HOLDING AG

# CONTENTS

END POSITION DETECTION SENSOR	5
CONTROL TYPES	6
CERTIFICATES / TEST CERTIFICATES	7
PILOT OPERATED SOLENOID VALVES	8
FORCE PILOT OPERATED SOLENOID VALVES	10
DIRECT ACTING SOLENOID VALVES	12
PRESSURE CONTROLLED VALVES	14
HIGH PRESSURE VALVES	18
REFRIGERATION AND CRYOGENIC VALVES	22
HIGH TEMPERATURE VALVES	24
SOLENOID VALVES FOR GAS APPLICATIONS	28
SOLENOID VALVES FOR UNDERWATER APPLICATIONS	29
4R PROPORTIONAL VALVES	30
4R ELECTRO-PNEUMATIC POSITIONERS	30
BLOCK SOLUTIONS	32
SOLENOIDS	34
ACCESSORIES	36
VALVE OPTIONS	37
ORDER NUMBER SYSTEMS	38
MATERIAL SPECIFICATIONS	39
FLANGE MASS AND OPERATING PRESSURES	40
ENQUIRY FORM	42

# END POSITION DETECTION SENSOR

	End position detection sensor	suitable for solenoid system .032 and .012
	Housing material	Stainless steel 1.4301 / 1.4105
	Supply voltage	12-24V DC
	Ambient temperature	-40 °C to +80 °C
	Electrical connection	M12x1 5-pin
	Thread / connection	G $\frac{1}{8}$ (others on request)
	Protection class	IP65 according to DIN EN 60529
	Option	LED connector incl. 3m cable



## OPERATING PRINCIPLE

The sensor is mounted on the tube where the fixing nut is positioned. No fixing nut is required for the electro-solenoid. The coil is fixed in position by the sensor. The sensor is connected by means of an M12x1 5-pin connector with integrated LED display. The sensor is then ready for operation.

When the electro-solenoid is switched on, this is indicated by the LED integrated into the connector. At the same time, an analogue 24V DC signal is generated via pin 5.

## CHARACTERISTICS

- For GSR solenoid systems .032 and .012
- Complete assembly with valve as option 6H
- Easy installation for retrofitting
- Visual detection of the end position by integrated LED

## NOTE

The limit switch signals as soon as the magnetic armature is in contact with the opposite pole. In order to ensure switching accuracy and switching reliability, the rated current of the solenoid must be constant!



# CONTROL TYPES

## PILOT OPERATED SOLENOID VALVES

Valves of this type require a pressure differential in the operating pressure for opening and closing. The min. pressure required for this is specified as the minimum pressure on the technical data sheet. The actuator only fulfills a pilot control function here, by means of which pressure on the main sealing element (diaphragm or piston) is relieved.

The medium pressure or the existing pressure difference raises the main seal. With this type of control, high pressures with large nominal widths can be controlled by small solenoids.

If the effective cross-section of the line on the media supply side is restricted, the switching behaviour may possibly become unstable, since the differential pressure fluctuates when the valve is closed.

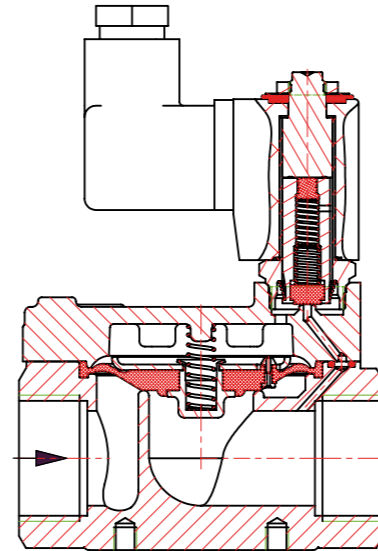

## FORCE PILOT OPERATED SOLENOID VALVES

Valves of this type operate from 0 bar and can also be used wherever directly controlled valves are used.

However, they are supplied with smaller solenoids for higher pressures and larger nominal widths beyond the range of application of the latter. The actuator opens a pilot bore and then lifts the sealing element from the main seat directly or supported by the  $\Delta p$  of the operating pressure.

The special feature of this control is that the actuator can open and close the valve without assistance from the operating pressure. If there is a pressure differential – usually when the valve is being opened – the available energy is also used.

If the effective cross-section of the line on the media supply side is restricted, the switching behaviour may possibly become unstable, since the differential pressure fluctuates when the valve is closed.

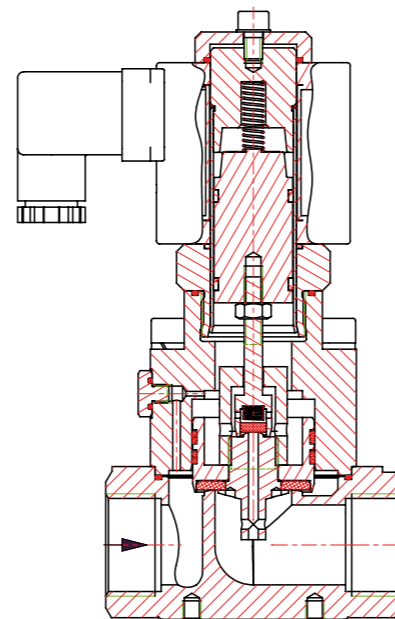

## DIRECT ACTING SOLENOID VALVES

Valves of this design operate the sealing element directly via the solenoid system. As a rule, the seal must lift off from the seat against the effective operating pressure solely by means of the actuator. Supported by the medium pressure, a closing spring keeps the valve closed.

The function depends on the seat size, the effective operating pressure and the magnetic force.

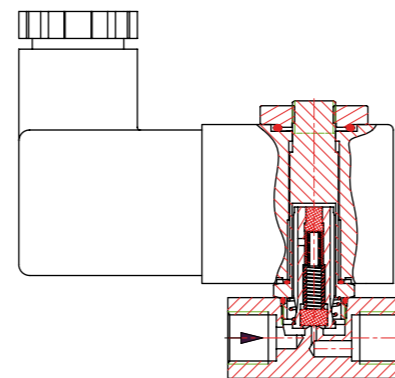

## PRESSURE CONTROLLED VALVES

Valves of this design are controlled by an externally operated pilot valve.



As a result, high temperatures, high pressures, contaminated media and aggressive operating media, etc. can be controlled with a clean control medium.

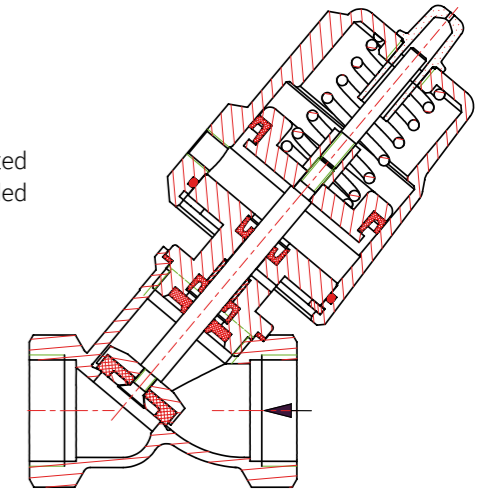

# CERTIFICATES

- DIN EN ISO 9001
- Type examination certificates in accordance with Gas Appliance Regulation EU2016/426 (DVGW)
- DNV-GL
- EAC
- UL approval (for NAFTA)
- and other certificates on request

# TEST CERTIFICATES

- Strength and tightness testing
- Factory certificate 2.2
- Acceptance test certificate 3.1 according to DIN EN 10204
- Acceptance test certificate 3.2 according to DIN EN 10204
- Certificate for material testing - Material batch certificates
- Certificate of origin



# SOLENOID VALVES

## PILOT OPERATED

### AREAS OF APPLICATION:









- Bottling plants
- Irrigation systems
- Well technology
- Plumbing equipment
- Water treatment
- Pneumatics
- Mixing plants
- Pipe construction
- Drinking water supply
- and many applications in general mechanical and apparatus engineering

### HOUSING AND SEAL MATERIALS:

- Housing with threaded sleeves: brass, stainless steel
- Housing with flange connection: Cast iron EN-GJL-250, cast steel GP240 GH, stainless steel, spheroidal cast iron EN-GJS-400-18-LT
- Seals made of NBR, EPDM, FKM, PTFE

### MEDIUM TEMPERATURE

- -30 °C to +80 °C

	Series	Design	Connection		Pressure range	Housing material	Link to data sheet	Medium temperature	
			Inner thread <i>Seat diameter</i>	Flange					
	40	2/2-way valve with diaphragm seal	G <sup>1</sup> / <sub>4</sub> -G3 13.5-80 mm	-	0.3-20 bar	Brass 2.0402 Stainless steel 1.4581		-10 °C/+80 °C	
	28	2/2-way valve with diaphragm seal	-	DN15-DN50	0.3-20 bar	Cast iron EN-GJL-250 Cast steel GP240 GH Stainless steel 1.4581		-10 °C/+80 °C	
	51	2/2-way valve with piston seal	G <sup>1</sup> / <sub>4</sub> -G2 13.5-50 mm	-	0.5-40 bar	Brass 2.0402 Stainless steel 1.4581		-20 °C/+80 °C	
	54	2/2-way valve with piston seal	-	DN15-DN50	0.5-40 bar	Cast iron EN-GJL-250 Cast steel GP240 GH Stainless steel 1.4581		-20 °C/+80 °C	
	25	2/2-way valve with piston seal	-	DN65-DN250	1-40 bar	Cast steel GP240 GH		-30 °C/+80 °C	

Pilot operated valves are characterized by a simple, solid design. Either a diaphragm for application pressures up to 20 bar or a piston for application pressures up to 40 bar are used as sealing elements. Valves of this type require a pressure differential in the operating pressure for opening and closing. The minimum pressure required for this is specified as the minimum pressure on the technical data sheet.

The solenoid system merely fulfils a pilot control function here, by means of which pressure on the main sealing element, the diaphragm or the piston, is relieved. The medium pressure or the existing pressure difference raises the main seal.

# SOLENOID VALVES

FORCE PILOT OPERATED

## AREAS OF APPLICATION:











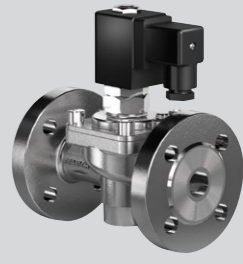

- Bottling plants
- Heating circuits
- Tank systems
- and many applications in general
- Boiler construction
- Power plant technology
- Water treatment
- mechanical and apparatus engineering
- Liquefied gas plants
- Petrochemical industry
- Pipe construction
- Drinking water supply
- Hot water applications
- Pump technology
- Drinking water supply

## HOUSING AND SEAL MATERIALS:

- Housing with threaded sleeves: Brass, stainless steel, PA66
- Housing with flange connection: Cast iron EN-GJL-250, cast steel GP240 GH, stainless steel, spheroidal cast iron EN-GJS-400-18-LT
- Seals made of NBR, EPDM, FKM, PTFE

## MEDIUM TEMPERATURE

- -40 °C to +80 °C

	Series	Design	Connection		Pressure range	Housing material	Link to data sheet	Medium temperature	
			Inner thread Seat diameter	Flange					
	43	2/2-way valve with diaphragm seal	G <sup>1</sup> / <sub>4</sub> -G2 13.5-50 mm	-	0-16 bar	Brass 2.0402 Stainless steel 1.4581		-10 °C/+80 °C	
	27	2/2-way valve with diaphragm seal	-	DN15-DN150	0-16 bar	Spheroidal cast iron EN-GJS-400-18-LT (DN150) Cast iron EN-GJL-250 (DN20-150) Stainless steel 1.4581 (DN15-50) Cast steel GP240 GH (DN15-100)		-10 °C/+80 °C	
	35	2/2-way valve with piston seal	G <sup>1</sup> / <sub>4</sub> -G3 13.5-80 mm	-	0-40 bar	Brass 2.0402 Stainless steel 1.4581		-40 °C/+80 °C	
	37	2/2-way valve with piston seal	-	DN15-DN50	0-40 bar	Cast iron EN-GJL-250 Cast steel GP240 GH Stainless steel 1.4581		-40 °C/+80 °C	
	24	2/2-way valve with piston seal	-	DN65-DN300	0-40 bar	Spheroidal cast iron EN-GJS-400-19-LT Cast iron EN-GJL-250 Cast steel GP240 GH Stainless steel 1.4581		-30 °C/+80 °C	
	39	2/2-way valve with diaphragm seal	G <sup>1</sup> / <sub>2</sub> -G <sup>3</sup> / <sub>4</sub> 15-20 mm	-	0-6 bar	PA66		0 °C/+40 °C	

Force pilot operated valves operate from 0 bar and can also be used wherever direct acting valves are used. However, they are supplied with smaller solenoids for higher pressures and larger nominal widths beyond the range of application of the latter. In the case of positively controlled valves, the actuator opens a pilot bore and then lifts the sealing element from the main seat directly or supported by a difference in the operating pressure.

The special feature of this type of control is that the actuator can open and close the valve in the pressure range without assistance from the operating pressure. In the event of a pressure difference, usually when the valve is being opened, the available energy is also used.

# SOLENOID VALVES

## DIRECT ACTING

### AREAS OF APPLICATION:











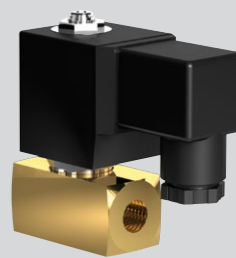

- Industrial and domestic gas supply
- Venting of gas and tank systems
- Safety valves for burner controls
- Pneumatics, series 52 and 72
- Vacuum technology

### HOUSING AND SEAL MATERIALS:

- Housing with threaded sleeves: brass, stainless steel
- Housing with flange connection: Cast iron EN-GJL-250, Cast steel GP240 GH, stainless steel
- Seals made of NBR, EPDM, FKM, PTFE

### MEDIUM TEMPERATURE

- -40 °C to +80 °C

	Series	Design	Connection		Pressure range	Housing material	Link to data sheet	Medium temperature	
			Inner thread Seat diameter	Flange					
	52	2/2-way valve with nipple seal	G <sup>1/8</sup> -G <sup>1/2</sup> 1-6 mm	-	0-90 bar	Brass 2.0401 / 2.0402 Stainless steel 1.4305 / 1.4571		-10 °C/+80 °C	
	72*	3/2-way valve with nipple seal	G <sup>1/8</sup> -G <sup>1/2</sup> 1-3 mm	-	0-90 bar	Brass 2.0401 / 2.0402 Stainless steel 1.4305 / 1.4571		-10 °C/+80 °C	
	75	3/2-way valve with nipple seal	G <sup>1/4</sup> 1-5 mm	-	0-40 bar	Brass 2.0402 Stainless steel 1.4408		-10 °C/+80 °C	
	73	3/2-way valve with plate seal	G <sup>1/4</sup> -G2 6-40 mm	-	0-20 bar	Brass 2.0401 / 2.0402 Stainless steel 1.4571		-30 °C/+80 °C	
	48	2/2-way valve with plate seal	Rp <sup>3/8</sup> -Rp3 8-75 mm	-	0-5 bar	Brass 2.0402 Stainless steel 1.4581		-40 °C/+80 °C	
	48FL	2/2-way valve with plate seal	12.5-75 mm	DN15-DN80	0-3 bar	Stainless steel 1.4408		-10 °C/+80 °C	
	2/131*	3/2-way directly controlled Cnomo actuator integrated screw connection	G <sup>1/8</sup> 1.5 mm	-	0-10 bar	Aluminium 3.2315 / Stainless steel			
	23	2/2-way valve with plate seal	-	DN15-DN100	0-1.4 bar	Cast iron EN-GJL-250 Cast steel GP240GH		-10 °C/+80 °C	

\* can also be used as a pilot valve for pressure-controlled valves

Direct acting valves operate the sealing element directly via the solenoid system. As a rule, the seal must lift off from the seat against the effective operating pressure solely by means of the actuator. Supported by the medium pressure, a closing spring keeps the valve closed. The function depends on the seat size, the effective operating pressure and the magnetic force.

Note on PTFE seat sealing for direct acting solenoid valves:  
PTFE is a hard plastic and can cause slight leaks at low pressures.  
We therefore only certify the leakage rate to DIN 3230 T3 in this case.

# VALVES

## PRESSURE CONTROLLED

### AREAS OF APPLICATION:

- Bottling plants
- Brewing technology
- Chemical plants
- Mixing plants
- Concrete and cement industry
- Vacuum technology
- Water treatment
- Pneumatics

### PLEASE NOTE:

For liquids, "closing against the media flow" is recommended as the direction of flow. Basic version: "with the media flow"

### HOUSING AND SEAL MATERIALS:

- Housing with threaded sleeves: brass, stainless steel
- Housing with flange connection: Cast iron EN-GJL-250, cast steel GP240 GH, stainless steel, spheroidal cast iron EN-GJS-400-18-LT
- Seals made of NBR, EPDM, FKM, PTFE

### MEDIUM TEMPERATURE

- -40 °C to +200 °C

	Series	Design	Connection		Pressure range	Housing material	Link to data sheet	Medium temperature	
			Inner thread Seat diameter	Flange					
	63 Straight seat	2/2-way valve with plate seal	G <sup>1</sup> / <sub>4</sub> -G <sup>1</sup> / <sub>2</sub> 6-13.5 mm	-	0-16 bar	Brass 2.0402 Stainless steel 1.4571 / 1.4581		-10 °C/+80 °C	
	63FL*	2/2-way valve with plate seal	-	DN15-DN80	0-40 bar	Stainless steel 1.4408 / 1.4571		-40 °C/+200 °C	
	63*	2/2-way valve with plate seal	G <sup>1</sup> / <sub>2</sub> -G3 12.5-76 mm	-	0-40 bar	Brass 2.0402 Gunmetal RG5 Stainless steel 1.4408		-40 °C/+200 °C	
	22*	2/2-way valve with plate seal	-	DN15-DN200	0-40 bar	Spheroidal cast iron EN-JS 1049 Cast iron EN-GJL-250 Cast steel GP240 GH Stainless steel 1.4408		-40 °C/+200 °C	
	78	3/2-way valve with plate seal	G <sup>1</sup> / <sub>2</sub> -G2 18-50 mm	-	0-40 bar	Gunmetal RG5 Stainless steel 1.4571 / 1.4581		-40 °C/+200 °C	
	79	3/2-way valve with plate seal	-	DN15-DN150	0-16 bar	Spheroidal cast iron EN-JS 1049 Cast iron EN-GJL-250 Cast steel GP240 GH		-40 °C/+200 °C	

\* also with 4R electro-pneumatic positioner - pages 32/33

Pressure controlled valves are suitable for the control of gaseous, highly viscous, somewhat soiled and aggressive media. The drive space is separated from the operating medium. A neutral or liquid medium (4-10 bar) is required for activation. Pilot valves are available in the usual standard voltages and can be supplied on request.

Since compressed air is present and available almost everywhere, this type of control is preferable for problematic media. On average, only 0.4 ltr. of air is used per switching process. A return line for the air as the control medium is not necessary, since it is released into the atmosphere during the switching process.



# VALVES

## PRESSURE CONTROLLED

### AREAS OF APPLICATION:

- Bottling plants
- Concrete and cement industry
- Brewing technology
- Vacuum technology
- Chemical plants
- Water treatment
- Mixing plants
- Pneumatics

### PLEASE NOTE:









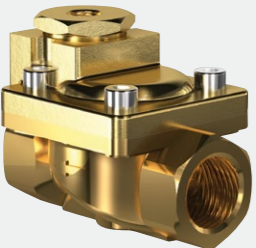

We recommend "closing against the media stream" as the flow direction for liquids.

### HOUSING AND SEAL MATERIALS:

- Housing with threaded sleeves: brass, stainless steel
- Housing with flange connection: Cast iron EN-GJL-250, cast steel GP240 GH, stainless steel, spheroidal cast iron EN-GJS-400-18-LT
- Seals made of NBR, EPDM, FKM, PTFE

### MEDIUM TEMPERATURE

- -40 °C to +200 °C

	Series	Design	Connection		Pressure range	Housing material	Link to data sheet	Medium temperature	
			Inner thread Seat diameter	Flange					
	60	2/2-way servo pressure controlled valve with diaphragm seal	G <sup>1</sup> / <sub>4</sub> -G2 13.5-50 mm	-	0.3-20 bar	Brass 2.0402 Stainless steel 1.4581		-10 °C/+80 °C	
	26	2/2-way pressure controlled valve with piston seal	-	DN15-DN300	0-40 bar	Spheroidal cast iron EN-GJS-400-18-LT Cast iron EN-GJL-250 Cast steel GP240 GH Stainless steel 1.4581 / 1.4408		-40 °C/+200 °C	
	2/668	2/3-way pressure controlled valve with plate seal	G <sup>1</sup> / <sub>2</sub> -G2 12-43 mm	-	0-7 bar	Gunmetal RG5 Stainless steel 1.4408		-10 °C/+80 °C	
	3/151	2/2-way pressure controlled valve with diaphragm seal	-	DN15-DN50	0-10 bar	Spheroidal cast iron EN-GJS-400-18-LT		-10 °C/+80 °C	
	2/292	3/2-way pressure controlled valve with plate seal	G <sup>1</sup> / <sub>4</sub> 3-5 mm	-	0-40 bar	Brass 2.0402 Stainless steel 1.4571		-10 °C/+80 °C	



OPTION G7

## ELECTRIC POSITION INDICATOR G7

For pressure controlled valves  
For monitoring, querying and visual display of valve positions or for activating other system components

- For actuators with control function, single and double-acting
- Display of 2 or 3 valve positions
- Backlash-free transmission of the valve position
- Short-circuit-proof
- M12, 5-pin connector A-coded
- Non-contact magnetic measuring method
- Compact and robust design
- Hermetically sealed
- Coloured LED display clearly visible throughout
- As a retrofit kit for existing actuators of series: 22, 26, 63, 78, 79
- Suitable for actuator sizes: ø50, ø80, ø125
- Mounting position 360° adjustable
- Initialisation with light source or 24V signal (5th pin) Initialisation protection
- High chemical resistance

Pressure controlled valves are suitable for the control of gaseous, highly viscous, somewhat soiled and aggressive media. The drive space is separated from the operating medium. A neutral or liquid medium (4-10 bar) is required for activation. Pilot valves are available in the usual standard voltages and can be supplied on request.

Since compressed air is present and available almost everywhere, this type of control is preferable for problematic media. On average, only 0.4 ltr. of air is used per switching process. A return line for the air as the control medium is not necessary, since it is released into the atmosphere during the switching process.

# HIGH-PRESSURE VALVES

## AREAS OF APPLICATION:

















- High-pressure pumps
- Paper processing industry for press beams
- Nitrogen applications
- Press and lock control
- Water and oil hydraulics
- Natural gas fuelling plants
- Hydrogen tanks
- Sheet greasing
- Metal forming
- Automotive industry
- Vehicle tank systems
- Fire extinguishing systems

## HOUSING AND SEAL MATERIALS:

- Housing made of brass, stainless steel
- Seals made of NBR, EPDM, FKM, PTFE

## MEDIUM TEMPERATURE

- -40 °C to +80 °C

	Series	Design	Connection	Seat diameter	Pressure range	Housing material	Link to data sheet	Medium temperature	
	55	2/2-way solenoid valve with nipple seal direct acting	G <sup>1</sup> / <sub>4</sub>	0.5 - 6.0mm	0-900 bar	Brass 2.0401 Stainless steel 1.4301 / 1.4462 / 1.4571		-40 °C/+80 °C	
	75HD	3/2-way solenoid valve with nipple seal direct acting	G <sup>1</sup> / <sub>4</sub>	1.0 - 5.0mm	0-300 bar	Brass 2.0401 Stainless steel 1.4301 (AISI 304)		-30 °C/+80 °C	
	8/000	2/2-way solenoid valve with piston seal pilot operated	G <sup>1</sup> / <sub>4</sub> & G <sup>1</sup> / <sub>2</sub>	8 / 15 mm	5-350 bar	Stainless steel 1.4301 (AISI 304)		-40 °C/+80 °C	
	2/529	2/2-way solenoid valve with piston seal pilot operated	G <sup>1</sup> / <sub>4</sub> -G2	12 -50 mm	1-450 bar	Stainless steel 1.4571		-40 °C/+80 °C	
	3/071	2/2-way solenoid valve with piston seal pilot operated	G <sup>1</sup> / <sub>4</sub> -G <sup>1</sup> / <sub>2</sub>	8 mm	5-900 bar	Stainless steel 1.4462		-20 °C/+60 °C	
	2/529pn	2/2-way valve with piston seal servo pressure controlled	G <sup>1</sup> / <sub>2</sub> -G2	13 -50 mm	1-600 bar	Stainless steel 1.4571		-40 °C/+80 °C	
	3/045	3/2-way solenoid valve with plate seal direct acting	G <sup>1</sup> / <sub>8</sub> -G <sup>1</sup> / <sub>2</sub>	10 mm	0-250 bar	Stainless steel 1.4571		-10 °C/+80 °C	
	8/100	2/2-way valve with plate seal directly pressure controlled	G <sup>1</sup> / <sub>8</sub> -G <sup>1</sup> / <sub>4</sub> 7/16 UNF - 9/16 UNF	0.5 - 8.0mm	0-1,000 bar	Stainless steel 1.4301 / 1.4501		-40 °C/+80 °C	

# HIGH-PRESSURE VALVES

## AREAS OF APPLICATION:















- High-pressure pumps
- Paper processing industry for press beams
- Nitrogen applications
- Press and lock control
- Water and oil hydraulics
- Natural gas fuelling plants
- Hydrogen tanks
- Sheet greasing
- Metal forming
- Automotive industry
- Vehicle tank systems
- Fire extinguishing systems

## HOUSING AND SEAL MATERIALS:

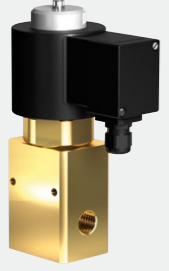
- Housing made of brass, stainless steel
- Seals made of NBR, EPDM, FKM, PTFE

## MEDIUM TEMPERATURE

- -40 °C to +80 °C

	Series	Design	Connection	Seat diameter	Pressure range	Housing material	Link to data sheet	Medium temperature	
	46	2/2-way solenoid valve with piston seal pilot operated	G <sup>1</sup> / <sub>4</sub> -G <sup>1</sup> / <sub>2</sub>	8 mm	1-100 bar	Stainless steel 1.4581		-40 °C/+80 °C	
	1/921	3/2-way valve with piston seal directly pressure controlled	G <sup>1</sup> / <sub>4</sub> -G1	10-22 mm	0-500 bar	Stainless steel 1.4571		-10 °C/+80 °C	
	52-S	2/2-way solenoid valve with nipple seal direct acting	G <sup>1</sup> / <sub>4</sub>	1-1.5 mm	0-150 bar	Brass 2.0401 Stainless steel 1.4305 Stainless steel 1.4571		-20 °C/+80 °C	
	1/041 FL	2/2-way solenoid valve with piston seal force pilot operated	Flange DN15 - DN100		0-130 bar	Steel C22.8 Stainless steel 1.4408		-40 °C/+80 °C	
	1/041	2/2-way solenoid valve with piston seal force pilot operated	G <sup>1</sup> / <sub>4</sub> -G2	13-50 mm	0-130 bar	Brass 2.0401 Stainless steel 1.4408		-40 °C/+80 °C	
	2/918	2/2-way coaxial solenoid valve	G <sup>3</sup> / <sub>8</sub> -G2	10-50 mm	0-100 bar	Brass 2.0401 Stainless steel 1.4305		-10 °C/+100 °C	
	3/918	3/2-way coaxial solenoid valve	G <sup>3</sup> / <sub>8</sub> -G1 <sup>1</sup> / <sub>4</sub>	10-50 mm	0-64 bar	Brass 2.0401 Stainless steel 1.4305		-10 °C/+100 °C	

# REFRIGERATION AND CRYOGENIC VALVES

DOWN TO -196 °C

## AREAS OF APPLICATION:



















- LNG handling
- Shock freezing in the food industry

## HOUSING AND SEAL MATERIALS:

- Housing with threaded sleeves: brass, stainless steel
- Housing with flange connection: Stainless steel
- Seals made of PTFE, PCTFE

## MEDIUM TEMPERATURE

- -196 °C to +90 °C

	Series	Design	Connection		Pressure range	Housing material	Link to data sheet	Medium temperature	
			Inner thread Seat diameter	Flange					
	K35	2/2-way solenoid valve with piston seal force pilot operated	G <sup>1</sup> / <sub>4</sub> -G2 13.5-50 mm	-	0-40 bar	Brass 2.0402 Stainless steel 1.4581		-60 °C/+80 °C	
	K37	2/2-way solenoid valve with piston seal force pilot operated	15-50 mm	DN15-DN50	0-40 bar	Cast iron EN-GJL-250 Cast steel GP240 GH Stainless steel 1.4581		-60 °C/+80 °C	
	K24	2/2-way solenoid valve with piston seal force pilot operated	-	DN65-DN100	0-40 bar	Stainless steel 1.4581		-60 °C/+80 °C	
	46TK	2/2-way solenoid valve with piston seal pilot operated	G <sup>1</sup> / <sub>4</sub> -G <sup>1</sup> / <sub>2</sub> 8 mm	-	1-16 bar 1-30 bar	Stainless steel 1.4581 Stainless steel 1.4404		-196 °C/+80 °C	
	K91	2/2-way solenoid valve with piston seal force pilot operated	G <sup>1</sup> / <sub>4</sub> -G2 13.5-50 mm	-	0-16 bar	Brass 2.0402 Stainless steel 1.4581		-196 °C/+80 °C	
	A91	2/2-way solenoid valve with piston seal force pilot operated	G <sup>1</sup> / <sub>4</sub> -G2 13.5-50 mm	-	0-16 bar	Brass 2.0402 Stainless steel 1.4581		-196 °C/+60 °C	
	B91	2/2-way solenoid valve with piston seal force pilot operated	G <sup>1</sup> / <sub>4</sub> -G2 13.5-50 mm	-	0-40 bar	Stainless steel 1.4404		-196 °C/+60 °C	
	A90	2/2-way valve with plate seal directly pressure controlled	G <sup>1</sup> / <sub>4</sub> -G2 13.5-50 mm	-	0-16 bar	Stainless steel 1.4581		-196 °C/+60 °C	
	B90	2/2-way valve with plate seal directly pressure controlled	G <sup>1</sup> / <sub>4</sub> -G2 13.5-50 mm	-	0-40 bar	Stainless steel 1.4404		-196 °C/+60 °C	

# HIGH TEMPERATURE VALVES

UP TO +200 °C

## AREAS OF APPLICATION:



















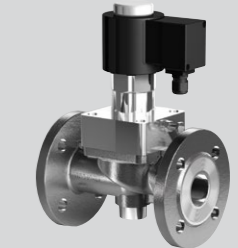

- Curing plants
- Blast furnace construction
- Coking plants
- Steam plants
- Steam turbines

## HOUSING AND SEAL MATERIALS:

- Housing with threaded sleeves: brass, stainless steel
- Housing with flange connection: Cast iron EN-GJL-250, Cast steel GP240 GH, stainless steel
- Seals made of FKM, EPDM, PTFE, PEEK, metallic

## MEDIUM TEMPERATURE

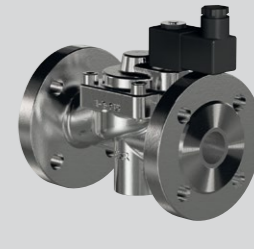
- -40 °C to +400 °C

	Series	Design	Connection		Pressure range	Housing material	Link to data sheet	Medium temperature	
			Inner thread <i>Seat diameter</i>	Flange					
	40TM	2/2-way solenoid valve with diaphragm seal, pilot operated	G <sup>1</sup> / <sub>4</sub> -G2 13-50 mm	-	0.3-20 bar	Brass 2.0402 Stainless steel 1.4581		up to +140 °C	
	28TM	2/2-way solenoid valve with diaphragm seal, pilot operated	-	DN15-DN50	0.3-20 bar	Cast iron EN-GJL-250 Cast steel GP240 GH Stainless steel 1.4581		up to +140 °C	
	43TM	2/2-way solenoid valve with diaphragm seal, force pilot operated	G <sup>1</sup> / <sub>4</sub> -G2 13.5-50 mm	-	0-16 bar	Brass 2.0402 Stainless steel 1.4581		up to +140 °C	
	27TM	2/2-way solenoid valve with diaphragm seal, force pilot operated	-	DN15-DN50	0-16 bar	Cast iron EN-GJL-250 (DN20-50) Cast steel GP240 GH (DN15-50) Stainless steel 1.4581 (DN15-50)		up to +140 °C	
	35TH	2/2-way solenoid valve with piston seal force pilot operated	G <sup>1</sup> / <sub>4</sub> -G2 13-50 mm	-	0-40 bar	Brass 2.0402 Stainless steel 1.4581		up to +180 °C up to +200 °C*	
	24TH	2/2-way solenoid valve with piston seal force pilot operated	-	DN65- DN200	0-40 bar	Spheroidal cast iron EN-GJS-400-19-LT Cast iron EN-GJL-250 Cast steel GP240 GH Stainless steel 1.4581		up to +180 °C up to +200 °C*	
	37TH	2/2-way solenoid valve with piston seal force pilot operated	-	DN15-DN50	0-40 bar	Cast iron EN-GJL-250 Cast steel GP240 GH Stainless steel 1.4581		up to +180 °C up to +200 °C*	
	25TH	2/2-way solenoid valve with piston seal pilot operated	-	DN65-DN150	1-13 bar	Cast iron EN-GJL-250 Cast steel GP240 GH		up to +200 °C	
	51TH	2/2-way solenoid valve with piston seal pilot operated	G <sup>1</sup> / <sub>4</sub> -G2 13.5-50 mm	-	0.5-40 bar	Brass 2.0402 Stainless steel 1.4581		up to +180 °C	
	54TH	2/2-way solenoid valve with piston seal pilot operated	-	DN15-DN50	0.5-40 bar	Cast iron EN-GJL-250 Cast steel GP240 GH Stainless steel 1.4581		up to +180 °C	

# HIGH TEMPERATURE VALVES

UP TO +400 °C

## AREAS OF APPLICATION:



















- Curing plants
- Blast furnace construction
- Coking plants
- Steam plants
- Steam turbines

## HOUSING AND SEAL MATERIALS:

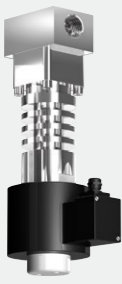
- Housing with threaded sleeves: brass, stainless steel
- Housing with flange connection: Cast iron EN-GJL-250, Cast steel GP240 GH, stainless steel
- Seals made of FKM, EPDM, PTFE, PEEK, metallic

## MEDIUM TEMPERATURE

- -40 °C to +400 °C

	Series	Design	Connection		Pressure range	Housing material	Link to data sheet	Medium temperature	
			Inner thread <i>Seat diameter</i>	Flange					
	63DT	2/2-way valve with plate seal directly pressure controlled	G <sup>1</sup> / <sub>2</sub> -G3 13-76 mm	-	0-40 bar	Gunmetal RG5 Brass 2.0402 Stainless steel 1.4408		up to +250 °C	
	24DT	2/2-way solenoid valve with piston seal force pilot operated	-	DN65-DN100	0-40 bar	Cast steel GP240 GH Stainless steel 1.4581		up to +250 °C	
	35DT	2/2-way solenoid valve with piston seal force pilot operated	G <sup>1</sup> / <sub>4</sub> -G2 13.5-50 mm	-	0-40 bar	Brass 2.0402 Stainless steel 1.4581		up to +250 °C	
	37DT	2/2-way solenoid valve with piston seal force pilot operated	-	DN15-DN100	0-40 bar	Cast steel GP240 GH Stainless steel 1.4581		up to +250 °C	
	63 DTE	2/2-way valve with plate seal directly force pilot operated	G <sup>1</sup> / <sub>2</sub> -G2 13-45 mm	-	0-40 bar	Stainless steel 1.4408 / 1.4571		up to +300 °C	
	2/164FL	2/2-way solenoid valve with piston seal force pilot operated	-	DN15-DN100	0-40 bar	Cast steel GP240 GH Stainless steel 1.4581		up to +300 °C	
	2/164	2/2-way solenoid valve with piston seal force pilot operated	G <sup>1</sup> / <sub>4</sub> -G2 13-50 mm	-	0-40 bar	Brass 2.0402 Stainless steel 1.4581 / 1.4571		up to +300 °C	
	2/640FL	2/2-way valve with plate seal directly pressure controlled	-	DN65-DN100	0-40 bar	Cast steel GP240 GH		up to +400 °C	
	2/640	2/2-way valve with plate seal directly pressure controlled	G <sup>1</sup> / <sub>4</sub> -G2 15-50 mm	-	0-40 bar	Cast steel GP240 GH Stainless steel 1.4571		up to +400 °C	

# SOLENOID VALVES



## FOR GAS APPLICATIONS

With approval under the Gas Appliance Regulation 2016/426/EU on the basis of DIN EN 161

Type of control	Direct acting, force pilot operated For a description of the operational principle, see p. 6
Design	Seat valve with diaphragm seal Seat valve with plate seal
Valve housing	Cast iron EN-GJL-250 and brass 2.0401
Pressure range	Positively controlled 0 - 6 bar Directly controlled 0 - 0.7 bar
Flow medium	Gaseous fuels acc. to 2009/142/EC
Seal	NBR and FKM
Connection voltage	AC~24V, 110V, 230V DC=12V, 24V, 110V Other connection voltages on request
Voltage tolerance	-10% / +10%
Degree of protection	IP65 according to DIN EN 60529
Duty cycle	100% ED-VDE 0580
Type of connection	Terminal box
Explosion protection	acc. to 2014/34/EU (ATEX)

- For gaseous fuels acc. to Gas Appliance Regulation
- Certified according to 2016/426/EU (test basis DIN EN 161)
- Requires no pressure difference
- Long service life
- High-quality materials
- Reliable, resilient sealing elements
- Optionally with 1 limit switch (-DW or -DW-D) for position indication "OPEN"

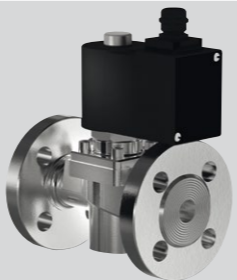

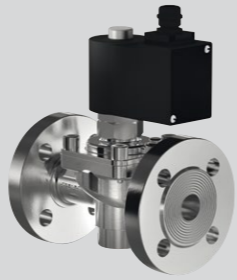
	Series	Design	Connection	
	G27DV	2/2-way solenoid valve with diaphragm seal force pilot operated	G1-G2	
	G27DV	2/2-way solenoid valve with diaphragm seal force pilot operated	DN25-DN300 PN16	
	G27DV-D	2/2-way solenoid valve with plate seal direct acting	G1-G2	
	G27DV-D	2/2-way solenoid valve with plate seal direct acting	DN25-DN300 PN16	

# SOLENOID VALVES

## FOR UNDERWATER APPLICATIONS



With encapsulated coil in accordance with IP68 protection for permanent operation under water up to 10 m water column

- for all 2/2-way solenoid valves

Solenoid	power VA for 50 Hz	Wattage
.032	24/15	11
.012	35/24	18.5
.702	incl. rectifier	25
.802	incl. rectifier	24
.322	incl. rectifier	30
.242	incl. rectifier	46
.272	incl. rectifier	100
.352	incl. rectifier	150
.402	incl. rectifier	250

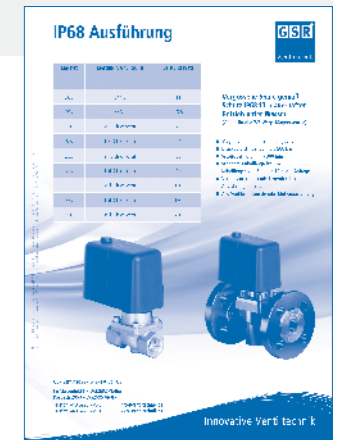
- Solenoid valves: all control types
- Pressure range: vacuum up to 900 mbar
- Seat sizes: 0.5mm - 300mm
- Standard cable length is 3 m  
Cable lengths of 5 m and 10 m on request
- Valves also available in a chemically nickel-plated version
- All valves in flange or socket design
- Not for explosion-proof or high temperature valves



	Series (example)	Design	
	43	2/2-way solenoid valve	
	27 35 ...	2/2-way solenoid valve force pilot operated	

# 4R PROPORTIONAL VALVES

## PRESSURE CONTROLLED CONTROL VALVES WITH ELECTRO-PNEUMATIC POSITIONER:





- For gaseous and liquid media
- High dosing accuracy
- No additional electronics for programming CE acc. to EMC DIN EN 61000
- Polarity reversal protection
- Ideal for continuous media control - even in higher temperature ranges
- Precise control behaviour
- Three safety position options: (Open/Closed/Unchanged)
- ROHS

## HOUSING AND SEAL MATERIALS:

- Gunmetal RG5, Stainless steel 1.4408, Stainless steel 1.4408
- Seals made of PTFE, FKM, EPDM

## MEDIUM TEMPERATURE

- -40 °C to +150 °C

	Series	Design	Connection		Pressure range	Housing material	Link to data sheet	Seal material	
			Inner thread	Flange					
	63-4R	Seat valve with control cone Slanted seat	G <sup>1</sup> / <sub>4</sub>	-	0-40 bar	Gunmetal RG5 Stainless steel 1.4408		PTFE	
	22-4R	Seat valve with control cone Straight seat, flange design	-	DN20-DN100	0-13 bar	Cast iron DN-GJL-250 Cast steel GP240 GH Stainless steel 1.4408		FKM, seat seal PTFE PTFE EPDM, seat seal PTFE	

## 4R ELECTRO-PNEUMATIC POSITIONER

	Auxiliary power	24 VDC max. 2.4W
	Input signal	4-20 mA, 0-10 V (output signal may differ from input signal)
	Adjustment	mechanical
	For actuator size	50, 80, 125 mm
	Ambient temperature	-15 °C / +60 °C
	Hysteresis	< 1%
	Control pressure	4-10 bar

## CHARACTERISTIC CURVE 63-4R / 22-4R

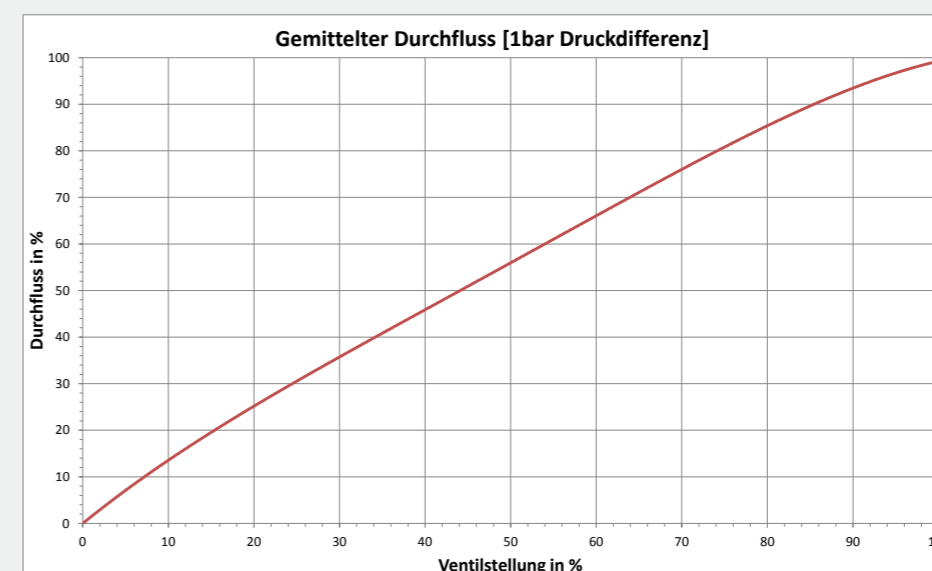

The characteristic curve shown is valid for all series. The corresponding Kv values are shown in the table for the specific valve. The characteristic curve is determined in accordance with VDI-EN 2173

## CONTROL BEHAVIOUR

Detection range	0-23 mm	Hysteresis	1%
Resolution	0.5% of max. stroke	Accuracy of response	1%
Repeat accuracy	99%	Setting range	1:200



# BLOCK SOLUTIONS

In addition to various valves with housings for connection in series, we also manufacture completely individual block valves and integrate all the other necessary components, such as check valves and sensors, in addition to our valves with solenoid or pneumatic actuators.

## OUR SERVICES INCLUDE:

- Design and construction of individual block solutions
- Manufacturing and testing
- Extensive technical documentation and consulting

## PILOT OPERATED DIAPHRAGM VALVE WITH SERIES HOUSING



Series 44, can be used for a pressure range of 0.5-16 bar, brass housing, various options for seals. A variety of solutions can be supplied with appropriate end and connection pieces. The example shows five individual components arranged in a block for fresh water distribution in various applications. Additional, individual connections according to customer requirements. Additional attachments, connection fittings and check valves were integrated individually according to customer specifications.



## HIGH-PRESSURE SOLENOID VALVE IN CARTRIDGE DESIGN



The pilot operated high-pressure solenoid valve made of stainless steel for screw fitting can safely control pressures up to 300 bar. Special versions are designed for pressures up to 900.

The example shows a compact block for gaseous media. Six cartridge valves, a filter, two overflow valves and various check valves were integrated. Cartridge valves make maintenance extremely easy.



32

## PRESSURE CONTROLLED HIGH-PRESSURE VALVE WITH SERIES HOUSING



Series 2/327, can be used for a pressure range of 0-100 bar, brass housing, durable seal made of PTFE. A variety of solutions can be supplied with appropriate end and connection pieces.

The example shows four individual valves arranged in a compact block for water distribution in various high-pressure applications. Additional attachments, connection fittings and check valves can be integrated individually according to customer specifications.



## VALVE BLOCK WITH DIRECT ACTING SOLENOID VALVES



The example shows a combination of six solenoid valves in the pressure range up to 8 bar.

The inputs and outputs can be positioned according to customer specifications. Various connection sizes and thread types can be supplied.

33

## DIRECT ACTING SOLENOID VALVE WITH FLANGE PLATE



Valves with flange plate made of brass or stainless steel in nominal widths from 0.5 mm to 10.0 mm. Pressure ranges up to 500 bar can be covered.

On request, we can manufacture block valves with a wide variety of attachments such as sensors, etc. according to customer specifications.

## VALVE BLOCK FOR HYDROGEN APPLICATIONS

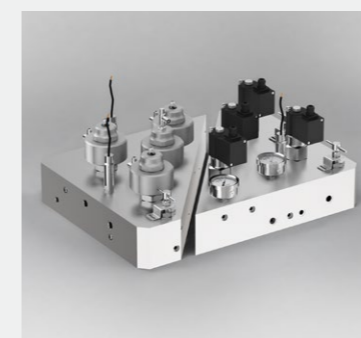

The example shows two options: a combination of 4 solenoid or pressure-controlled valves for the high-pressure range up to 1,000 bar.

In addition, sensors, filters, manual and check valves and pressure gauges can be integrated.

# SOLENOIDS

## COIL VARIANTS:

- Standard coils for general applications
- Coils for higher temperature ranges
- Explosion-proof coils according to Directive 2014/34/EU (ATEX)
- Coils with UL approval

## STANDARD CONNECTION VOLTAGES:

- AC~/Explosion protection: 24V, 110V, 230V
- DC~/Explosion protection: 12V, 24V

## PROTECTION CLASS:

- IP65

	Article number	Design	Power		Connection	Medium temperature	
			AC	DC			
	K051....	Standard	10.5 VA - 24 VA	6.8 W - 250 W	Plug, terminal box	-40 °C to +80 °C	
	KD51... KR51... KT51...	Temperature	24 VA	18.5 W - 180 W	Plug, terminal box	-40 °C to +300 °C	
		K059....	Explosion protection (ATEX)	3.1 VA - 10 VA	5.2 W - 75 W	Cable end, terminal box	
K05927...KL		Explosion protection (ATEX)	-	47 W	Terminal box, heat sink	-40 °C to +70 °C	
	K051....UL	UL approval	5.7 VA - 24 VA	5.7 W - 150 W	Plug, terminal box	-20 °C to +80 °C	

## HEATING AND POWER OF SOLENOIDS

GSR standard solenoid valves are designed for continuous operation (100% = duty cycle) under normal operating conditions.

The traction force of a solenoid coil is essentially influenced by three factors:

- self-heating
- medium temperature
- ambient temperature

GSR solenoids are designed as standard for a maximum ambient temperature of +35 °C. This specification applies to the maximum permissible operating pressure indicated on the respective valve data sheet and a medium temperature of 80 °C.

A higher ambient temperature is possible if lower values apply to the other influencing parameters. In addition, deviations from the default temperature range are possible if temperature coils are used, for example, or other design measures are taken. Please consult GSR headquarters in advance on a case-by-case basis.

For detailed information about the operating conditions, please refer to the data sheets for the corresponding solenoid and solenoid valve.

Please note that the surface temperature of a coil under continuous load can heat up to +120 °C solely as a result of self-heating. The power consumption of our standard solenoids was determined according to DIN VDE 0580 at a coil temperature of +20 °C.

# ACCESSORIES

## CLOCK GENERATOR

	Digital clock generator for mounting on solenoids (according to DIN43 650-M2)	
	ON/OFF function	
	Breaks and working hours	0.1 sec to 99 hours – adjustable on the device
	Ambient temperature	-10 °C to +50 °C
	Protection class	IP65
	max. permissible switching current	1 A

## SWITCHING ELECTRONICS 240 / 320

	Energy-saving – up to 75% lower energy consumption
	Reduction of heating
	Extension of the solenoid coil life
	Use of smaller solenoid coils due to overexcitation and power reduction
	Mounting on EN mounting rail
	Supply voltage 230V; 40-60 Hz
	Tightening voltage 205 VDC; holding voltage 102 VDC

## SEPARATE RECTIFIER

	For installation in control cabinets
---	--------------------------------------

## LIMIT SWITCH

	As a changeover in EEx version
---	--------------------------------

## HOOD

	For solenoids for outside mounting, <b>Solenoid types:</b> 802, NC 322, NC 242, NC 272, NC 352, NC also for NO and limit switch design
---	--

## ELECTRIC POSITION INDICATOR G7

	for pressure-controlled valves for monitoring, querying and visual representation of valve positions or for activation of other system components see also page 16/17
---	---

# VALVE OPTIONS

Option	Description	Comment
<b>For solenoid valves and pressure controlled valves</b>		
NG	Internal NPT connection thread	
TT	UNF connection thread (Autoclave)	
AS	Welding ends	
FL	Flange according to DIN EN 1092-1 Form B1/B2	
F1	Flange according to DIN EN 1092-1 Form D (groove)	
AF	ANSI flange according to Class 150 ASME B 16.5	
AX	ANSI flange according to Class 300 ASME B 16.5	
NO	Normally open valve	
HA	Manual operation	max. 200 bar
OA	Complete valve but without fitting/housing	
VW	Free of substances that interfere with paint wetting	
GD	Back pressure-resistant design	
CN	Chemically nickel-plated valve	
UN	Universal function (each connection can be pressurized)	for 3/2-way valves

<b>for solenoid valves</b>		
AA	Armature housing seal	for aggressive media
BF	Version free of non-ferrous metal	
SR	Adjustable closing damping	
MF	Suitable for installation with horizontal solenoid	
EA	1 electrical limit switch (reed contact, normally open contact)	DN15 / G <sup>1</sup> / <sub>2</sub> "
EH	1 electrical limit switch (reed contact, changeover contact)	from DN20 / G <sup>3</sup> / <sub>4</sub> "
EJ	2 electrical limit switches (reed contact, changeover contact)	from DN20 / G <sup>3</sup> / <sub>4</sub> "
EX	1 limit switch (reed contact), ATEX version	from DN20 / G <sup>3</sup> / <sub>4</sub> "
EZ	2 limit switches (reed contact), ATEX version	from DN20 / G <sup>3</sup> / <sub>4</sub> "
EL	Electrical reversing (for high tightening and low holding power)	only 230V AC
1W	Special design for hydrogen applications	recommended from 150 bar

<b>for pressure controlled valves</b>		
VU	Vacuum design	
VD	Vacuum and pressure design	
AHEM	Stroke volume control	
EP	1-way mechanical limit switch	
G7	Inductive position sensor with LED display	
DW	Double-action actuator	
IV	Inner parts stainless steel 1.4571 / AISI 316 Ti	
KJ	Tri-clamp connectors	

Note: The options listed here are just a selection.

# ORDER NUMBER SYSTEMS

## SOLENOID VALVES

. 37 01 / 08 04 / . 32 2 - E H

Series	Connection	Seal material	Housing material
23	2/2-way solenoid valve	01 DN15	00 Metal
24	2/2-way solenoid valve	02 DN20	01 NBR
25	2/2-way solenoid valve	03 DN25	02 FKM
27	2/2-way solenoid valve	04 DN32	04 PTFE
37	2/2-way solenoid valve	05 DN40	06 EPDM
40	2/2-way solenoid valve	06 DN50	...
43	2/2-way solenoid valve	07 DN65	...
44	2/2-way solenoid valve	...	...
46	2/2-way solenoid valve	21 G 1/4	06 Stainless steel 1.4305
48	2/2-way solenoid valve	22 G 3/8	08 Stainless steel 1.4581 / Stainless steel 1.4571
49	2/2-way solenoid valve	23 G 1/2	09 Stainless steel 1.4104
50	2/2-way solenoid valve	...	10 Brass
51	2/2-way solenoid valve	28 G 2	11 Gunmetal
53	2/2-way solenoid valve	29 G 2 1/2	...
...	...	30 G 3	...

### Solenoid system

### Valve options



## PRESSURE CONTROLLED VALVES

. 63 25 / 08 04 / 8 1 05 - X X

Series	Connection	Seal material	Housing material	Actuator options	Actuator size	Valve options
22	2/2-way pressure controlled	03	03	7	03	X
26	2/2-way pressure controlled	05	05	8	05	X
60	2/2-way pressure controlled	08	08	9	08	
63	2/2-way pressure controlled	13	13		13	
...	...	16	16		16	
...	...	20	20		20	

with the medium flow		against the medium flow	
03	Ø = 30	53	Ø = 30
05	Ø = 50	55	Ø = 50
08	Ø = 80	58	Ø = 80
13	Ø = 125	63	Ø = 125
16	Ø = 160	66	Ø = 160
20	Ø = 200	70	Ø = 200

Actuator options	Actuator size
0 Straight seat	03 Ø = 30
1 Slanted seat	05 Ø = 50
3 Control cylinder stainless steel 1.4581	08 Ø = 80
5 Control cylinder pressed brass-nickel-plated	13 Ø = 125
	16 Ø = 160
	20 Ø = 200



Information on the type code is explained on the corresponding data sheets for each valve.

# MATERIAL SPECIFICATIONS

The specific application is fundamental to the valve design, with the resistance of the materials to the operating medium as the crucial factor here. Knowledge of the concentration, temperature and degree of contamination of the medium is crucial for the correct choice of material. Other criteria include the operating pressure and max. volume flow, as not only high temperatures, but also high pressures and flow velocities must be taken into account when selecting materials. All materials for our valves, whether for housings, seals or solenoids, are carefully selected according to the specific areas of application. All information is non-binding and serves as a guide only. It is not a basis for any warranty claims.

Metallic materials			
Material	Material no.	DIN	Properties
Brass	2.0401	CuZn39Pb3	Versatile use. Not suitable for aggressive media or media that contain ammonia.
	2.0402	CUZn39Pb2	
Cast iron	EN-JL 1040	GG-25	Mainly for flange valve housings up to PN 16. The temperature range is limited. Suitable for neutral media.
		GGG-40.3	Mainly for flange valve housings up to PN 25. Used where GG-25 is too brittle. Suitable for neutral media.
Spheroidal cast iron	EN-JS 1025	GGG-40.3	Mainly for flange valve housings up to PN 40 and higher temperature ranges. Suitable for neutral media.
Cast steel	GP 240 GH	GS-C25	Can be used where brass is unsuitable, e.g. for seawater, slightly aggressive water or steam.
Gunmetal	CC491K	CuSn5Zn5Pb5-C DINEN1982	Austenitic high-alloy steel for aggressive media.
Cast stainless steel	1.4581	G-X5CrNiMoNb19-11-2	Austenitic high-alloy steel for solenoid armature tubes and aggressive media.
Stainless steel	1.4571	X6CrNiMoTi17-12-2	Austenitic high-alloy steel for solenoid armature tubes and aggressive media.
Stainless steel	1.4301	X5CrNi18-10	High-alloy austenitic stainless steel for internal valve parts and mildly aggressive media.
Stainless steel	1.4104	X14CrMoS17	Corrosion-resistant ferritic (magnetisable) stainless steel for e.g. solenoid armature and pole shoe. Suitable in some cases for aggressive media.
Aluminium	3.2162.05	AlSi8Cu3	Aluminium die casting. For neutral media.

Plastics	
PVC, polyvinyl chloride	Resistant to most acids, alkalis, salt solutions and water-miscible organic solutions. Not resistant to aromatic and chlorinated hydrocarbons.
PVDF, polyvinylidene fluoride	Suitable for almost all aggressive media in the temperature range from -20 °C to +100 °C.
PFA, fluoroplastic	As resistant as PVDF, but for an extended temperature range from -20 °C to +150 °C.
PP, polypropylene	Resistant to aqueous solutions of acids, alkalis and salts, depending on concentration and temperature.
POM, polyoxymethylene	Material with high hardness and low water absorption. Not for bases, acids or oxidising agents.

Sealing materials		
Material	Temperature range °C	Properties
NBR-acrylonitrile-butadiene rubber	-10 °C to +80 °C	Elastic standard material for neutral media such as air, water. Good resistance to mechanical stresses.
EPDM ethylene-propylene rubber	-10 °C to +130 °C	Resistant to alkalis and acids, rubber of medium concentration, water, hot water and steam. Not resistant to oils and greases.
FKM-fluorine rubber	-10 °C to +80 °C	Elastomer with high temperature and weather resistance. Suitable for many acids, bases, fuels and oils (including synthetic). Unstable in hot water and steam.
H-NBR	-35 °C to +150 °C	Elastomer with high ozone, aging and weather resistance. Suitable for dilute acids, oils (animal and vegetable) and salt solutions.
PTFE polytetrafluoroethylene	-180 °C to +200 °C	A thermoplastic, i.e. not an elastic material and therefore unsuitable for "classic" membranes (separating films are possible). Valve housings and internal valve parts are also manufactured from this material.
Peek	-200 °C to +300 °C	A thermoplastic, i.e. not an elastic material and therefore unsuitable for "classic" membranes (separating films are possible). Suitable for extremely high temperatures and high pressures.

# FLANGE DIMENSIONS AND OPERATING PRESSURES

ACCORDING TO EN 1092-1 FORM B1

Nominal width		PN 16				PN 25				PN 40			
DN		D	K	n	d	D	K	n	d	D	K	n	d
10	3/8	90	60	4	14	90	60	4	14	90	60	4	14
15	1/2	95	65	4	14	95	65	4	14	95	65	4	14
20	3/4	105	75	4	14	105	75	4	14	105	75	4	14
25	1	115	85	4	14	115	85	4	14	115	85	4	14
32	1 1/4	140	100	4	19	140	100	4	19	140	100	4	19
40	1 1/2	150	110	4	19	150	110	4	19	150	110	4	19
50	2	165	125	4	19	165	125	4	19	165	125	4	19
65	2 1/2	185	145	4	19	185	145	8	19	185	145	8	19
80	3	200	160	8	19	200	160	8	19	200	160	8	19
100	4	220	180	8	19	235	190	8	23	235	190	8	23
125	5	250	210	8	19	270	220	8	28	270	220	8	28
150	6	285	240	8	23	300	250	8	28	300	250	8	28
200	8	340	295	8	22	360	310	12	28	375	320	12	31
250	10	405	355	12	26	425	370	12	31	450	385	12	34
300	12	460	410	12	26	485	430	16	31	515	450	16	34

Note: Flange connections according to EN 1092-1 Form B2 for operating pressures from PN63 to PN100 optional

ANSI B 16.5 Class 150									
DN	15	20	25	32	40	50	65	80	100
D	90	100	110	115	125	150	180	190	230
Lk	60.3	69.9	79.4	88.9	98.4	120.7	139.7	152.4	190.5
d	15.7	15.7	15.7	15.7	15.7	19.1	19.1	19.1	19.1
n	4	4	4	4	4	4	4	4	8

ANSI B 16.5 Class 300									
DN	15	20	25	32	40	50	65	80	100
D	95	115	125	135	155	165	190	210	255
Lk	66.7	82.6	88.9	98.4	114.3	127.0	149.2	168.3	200.0
d	15.7	19	19	19	22.3	19	22.3	22.3	22.3
n	4	4	4	4	4	8	8	8	8

Valve lengths for flange fittings														
Flange DN	15	20	25	32	40	50	65	80	100	125	150	200	250	300
Overall length EN 558-1, Series 1 (mm)	130	150	160	180	200	230	290	310	350	400	480	600	730	850

DN = Nominal width  
 D = Outside diameter  
 K = Pitch circle diameter  
 n = Number of flange holes  
 d = Hole diameter

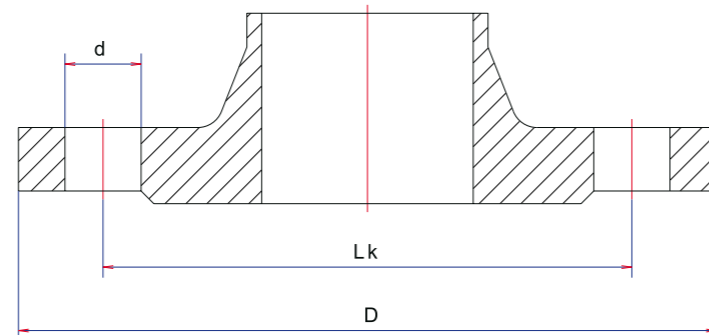

**Option A5:**  
 Valve body material 1.4408 DIN11850-2

**Option A9:**  
 Valve body material 1.4408 EN ISO1127/ ISO4200

**Option A:**  
 Valve body material 1.4408 DIN3239

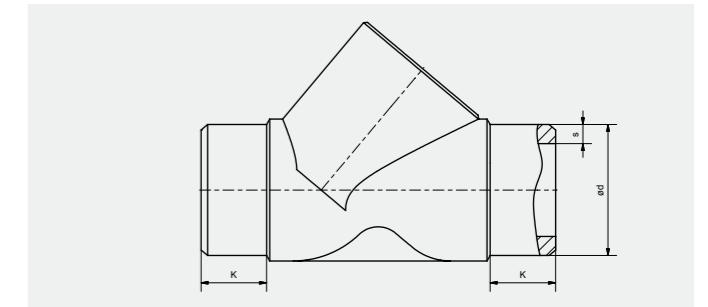

## Welding ends (mm)

DN	Option A5			Option A9			Option AS		
	Ø d	s	k	Ø d	s	k	Ø d	s	k
15	19	1.5	4.5	21.3	1.6	5	24	3.5	12
20	23	1.5	5.5	26.9	1.6	5	30	4	12
25	29	1.5	5.5	33.7	2	10	36	4	14
32	35	1.5	6	42.4	2	5	45	5	17
40	41	1.5	6	48.3	2	6	52	5.5	18
50	53	1.5	6.5	60.3	2.6	7	65	5.5	22

Clamp connection, valve body material 1.4408  
 DIN 32676 = Option KJ

DN	LG	LB	Ø d1	Ø d3
15	130	48	16	34
20	145	54	20	34
25	160	56	26	50.5
32	180	60.5	32	50.5
40	200	67	38	50.5
50	230	73	50	64

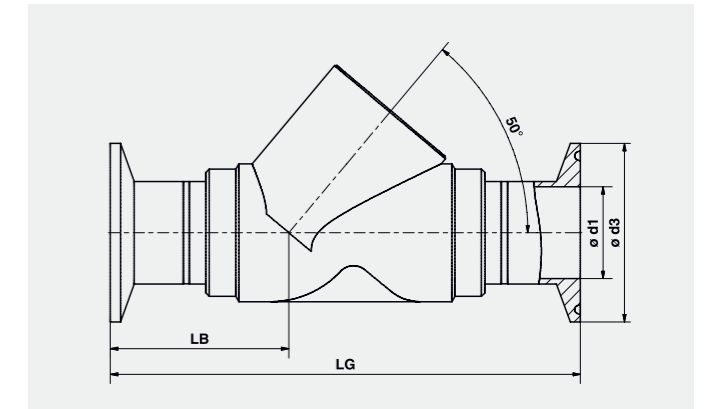

Flange connection acc. to EN 1092-1 Form B1 and  
 EN 558-1 Series 1

DN	L	K			Lk	D	d
		7105	7108	7113			
15	130	157	-	-	65	95	14
20	150	156	-	-	75	105	14
25	160	166	202	-	85	115	14
32	180	181	213	-	100	140	18
40	200	186	220	293	110	150	18
50	230	197	231	304	125	165	18

Also available as ANSI flange connection acc. to Class 150/300 ASME B16.5 available

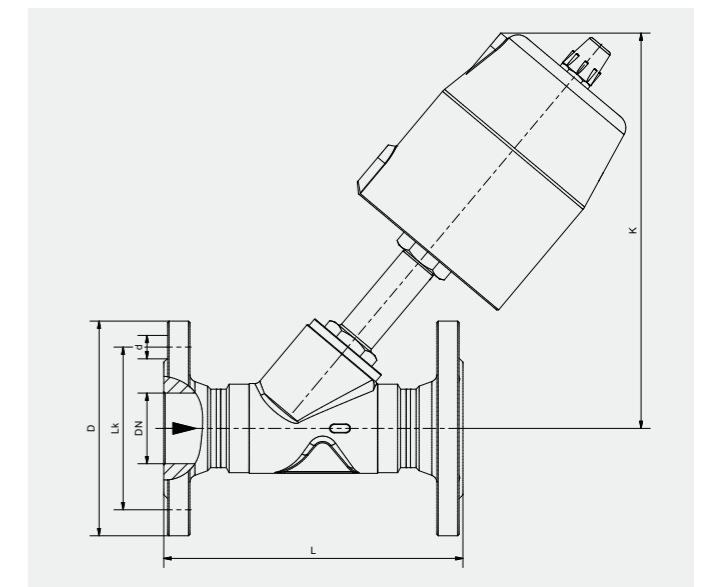

# ENQUIRY FORM

## Sender

Company _____	Name _____
Telephone _____	Fax _____
E-mail _____	

## Valve type

<input type="checkbox"/> Solenoid valve	<input type="checkbox"/> Externally controlled valve	<input type="checkbox"/> Other _____	
<input type="checkbox"/> 2/2-way	<input type="checkbox"/> 3/2-way	<input type="checkbox"/> Other _____	
<input type="checkbox"/> NC	<input type="checkbox"/> NO	<input type="checkbox"/> UN (universal function)	<input type="checkbox"/> Other _____

## Material

Housing _____	Seal _____
---------------	------------

## Pressure range

bar _____	psi _____	delta p _____
-----------	-----------	---------------

## Number of items

_____
-------

## Connection

Socket valve G _____	Flange valve DN _____	Other _____
----------------------	-----------------------	-------------

## Medium

_____
-------

## Viscosity

mm <sup>2</sup> /s _____	Other _____
--------------------------	-------------

## Flow rate

m <sup>3</sup> /h _____	l/min _____	Other _____
-------------------------	-------------	-------------

## Connection voltage

AC _____	DC _____
----------	----------

## Temperature

Medium _____	Environment _____
--------------	-------------------

## Explosion protection

<input type="checkbox"/> Yes, protection class _____	<input type="checkbox"/> No
--	-----------------------------

## Preferred delivery time

_____
-------

## Options/Extras

_____
-------

## Comments

_____
_____
_____



**GSR Valve Technology  
GmbH & Co. KG**

In Meisenfeld 1  
D-32602 Vlotho, Germany

T +49 5228 779-0 F -190  
**info@ventiltechnik.de**

**www.ventiltechnik.de**

The GSR logo is a registered trademark of GSR Ventiltechnik GmbH & Co. KG  
Original products may differ from the product photos shown because of different materials, etc.  
Subject to errors and changes.  
**GSR-004-KL-EN-02-2022**